

# Handling Instructions

## For SHTxx Humidity and Temperature Sensors

Sensirion’s relative humidity and temperature sensors SHTxx (where xx serves as placeholder) offer best in class performance in a broad range of applications. However, to make the most of their excellent performance, it is important to take some precautions during storage, assembly, and packaging. We recommend to carefully review these handling instructions, ideally during the design-in phase and before production release. Special attention should be paid to avoiding exposure to volatile organic compounds in high concentrations and/or for long periods of time, particularly during manufacturing and storage. Therefore, proper handling to mitigate any risks and correct material selection is crucial to ensure highest performance. Application of SHTxx in the field in ambient environment is not critical.

### Key Instructions

- Protection against ESD is mandatory.
- Do not use polyethylene antistatic bags.
- Do not apply board wash.
- Do not apply spray to unprotected sensor.
- Be careful exposing the sensor to VOC.
- Prevent sensor from exposure to cleaning agents.
- Cover the sensing element during coating.

This document is applicable to all Sensirion SHTxx humidity and temperature sensors.

### Contents

1	General.....	2
1.1	ESD.....	2
1.2	Storage.....	2
1.3	Exposure to chemicals.....	4
2	Assembly.....	4
3	Operation in the Field.....	9
4	Extreme Conditions and Reconditioning.....	9
5	Removable Protective Cover.....	10
6	Bibliography.....	11
7	Disclaimer.....	11
8	Revision History.....	11

Scan me to provide feedback



# 1 General

## 1.1 ESD

To ensure proper functioning of the sensor, it must be protected from Electrostatic Discharge (ESD) at all times. All handling of the sensor should take place exclusively in Electrostatic Discharge Protected Areas (EPAs) that have been properly set up to minimize the risk of ESD. This includes grounding personnel with wrist-straps or similar measures, grounding all conductive objects and excluding insulating materials from the EPA. Additionally, all operations should be conducted on a grounded conductive floor. To further protect the sensor, it should be packaged using ESD protective materials when not being handled within an EPA.

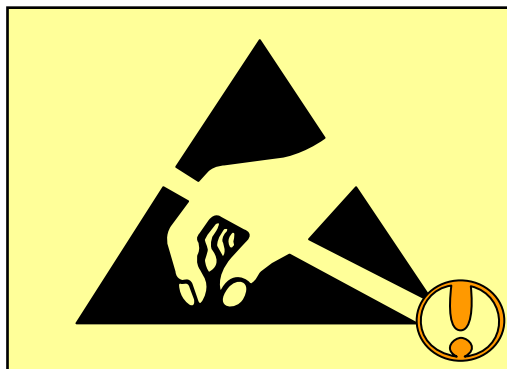

**Instruction 1.** Protection against ESD is mandatory.

## 1.2 Storage

To ensure optimal performance of the sensors, we strongly recommend storing them in the original sealed ESD bag prior to assembly or use. The ideal storage conditions for the sensors are as follows:

- Temperature: 10 °C...50 °C (0...125 °C for a limited time)
- Humidity: 20...60 %RH (sensors that are not stored in ESD bags).

By following these guidelines, you can ensure that the sensors are in the best possible condition for assembly and use.

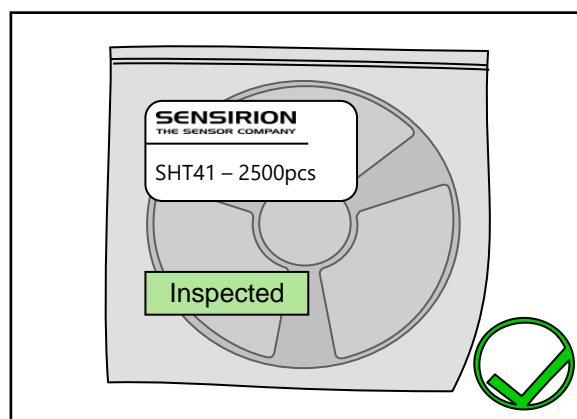

**Instruction 2.** Store sensors in original, unopened ESD bag. Place additional stickers only on the outside of the ESD bag.

To ensure the longevity and accuracy of your sensors, we recommend storing them in metal-in antistatic shielded ESD bags once they have been removed from their original packaging. This will help protect the sensors from electrostatic discharge and other external influences.<sup>1</sup>

Additionally, we recommend to not use any adhesive or adhesive tapes to reseal the sensor bag after opening. This can help avoid contamination and maintain the integrity of the sensor. The ESD bags listed in **Table 1**. ESD Bag compatibility can be recommended for this purpose, as they do not have a polluting effect on the humidity sensor.

Manufacturer	Product	Compatibility
Stroebel	Topshield Bags	Compatible

**Table 1.** ESD Bag compatibility

When packaging sensors, it is important to ensure that the materials used do not have the potential to cause sensor pollution. To maintain the accuracy and longevity of your sensors, only use packaging materials that do not outgas.

Metal-in antistatic shielded ESD bags, paper or cardboards based packaging, and deep-drawn plastic trays such as PE, PET, and PP may be considered. Do not use antistatic polyethylene bags, bubble foils, and foams, as they may contaminate the sensor. Additionally, be cautious when using stickers inside the packaging, as they can also cause contamination if not used properly. Sticker size should be kept to a minimum, and the sticky side should fully adhere to a surface.

It is important to note that many packaging materials may contain additives (plasticizers) that can have a polluting effect on the sensor. As a general rule, if a material emits a strong odour, it should not be used. Additionally, even materials that are recommended for use may contain additives, so it is important to be aware of this when selecting packaging materials.

For high safety and to ensure that the sensor is not affected, it is recommended to conduct a qualification test on the final device housing and shipment packaging<sup>2</sup>. Such a test may include exposing the final device with the sensor in its shipment packaging to a temperature of  $\geq 65$  °C for at least 168 hours. If shipping or storage conditions are expected to be harsh, the qualification test conditions for the packaging material should be customized. The sensor reading should show no deviation from a reference compared to the same measurements taken before the exposure.

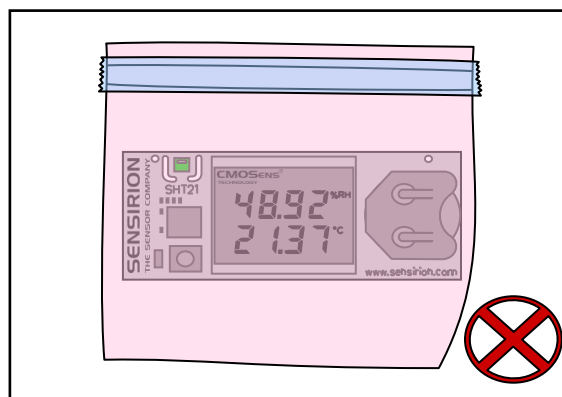

**Instruction 3.** Do not use polyethylene antistatic bags (light blue, pink or rose color). Do not use adhesive tapes inside packaging.

If you need guidance on testing your humidity sensors, we recommend consulting the “Testing Guide for Humidity Sensors” [1]. This guide will provide you with simple and straightforward instructions to help you

<sup>1</sup> This recommendation also applies to devices with assembled sensors.

<sup>2</sup> Especially for harsh shipping conditions.

ensure your sensors are working correctly. Furthermore, in case of doubt, kindly contact the Sensirion support line.

### 1.3 Exposure to chemicals

Humidity and temperature sensors are highly accurate environmental sensors that require special care to ensure optimal performance. The sensors are susceptible to pollutants and must be protected from exposure to volatile chemicals, acids, bases, and cleaning agents. Especially Ketenes, Acetone, Ethanol, Isopropyl Alcohol, Toluene, *etc.*<sup>3</sup>, might cause drift, in some cases even irreversible. To ensure the sensors maintain their outstanding performance, it is important to follow these guidelines:

- Avoid exposing the sensor to pollutants, especially volatile chemicals such as solvents or organic compounds. High concentrations and long exposures should be avoided, as they can cause drift in the humidity reading or even irreversibly damage the sensor.
- Be aware that certain chemicals are often found in epoxies, glues, adhesives, and plastics, and may outgas during baking and curing, potentially affecting the sensor.
- Avoid exposure to acids and bases, as they can irreversibly damage the sensor. These include HCl, H<sub>2</sub>SO<sub>4</sub>, HNO<sub>3</sub>, and NH<sub>3</sub>. High concentrations of ozone or H<sub>2</sub>O<sub>2</sub> should also be avoided.
- Avoid contact with cleaning agents, such as PCB board wash after soldering, or strong air blasts from an air-pistol<sup>4</sup>, as they can cause drift in the reading or complete breakdown of the sensor.
- Ensure good ventilation to avoid high concentrations of volatile chemicals, such as solvents, cleaning solutions, and detergents, *e.g.* ethanol, isopropanol, methanol, acetone, *etc.*

Please note that this is not a complete list of harmful substances, and it is important to carefully read the application notes and follow all the guidelines provided to ensure optimal performance of the sensor.

## 2 Assembly

The sensors can be soldered using standard reflow soldering ovens. They are designed to withstand the soldering process, including the profile according to IPC/JEDEC J-STD-020 with peak temperatures at 260 °C for up to 30 seconds during Pb-free assembly in IR/Convection reflow ovens (see **Figure 1**).<sup>5</sup>

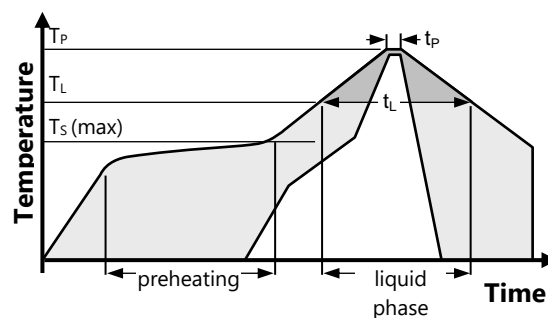

**Figure 1.** Soldering profile according to JEDEC standard.  $T_P \leq 260 \text{ °C}$  and  $t_P \leq 30 \text{ sec}$  above  $255 \text{ °C}$  for Pb-free assembly.  $T_L < 220 \text{ °C}$  and  $t_L < 150 \text{ sec}$ . Ramp-up rate  $< 3 \text{ °C}$  and ramp-down rate  $< 6 \text{ °C/sec}$  for temperatures  $> T_L$ .

<sup>3</sup> Such chemicals are integral part of epoxies, glues, adhesives, *etc.* and outgas during baking and curing. These chemicals are also added as plasticisers into plastics, used for packaging materials, and do out-gas for some period.

<sup>4</sup> Oil free air does not cause any harm to the sensor.

<sup>5</sup> Vapor phase soldering may not be recommended for the assembly of this specific product. If no alternative options are available, it is advised that the end-user or a qualified party conducts a compatibility qualification. Please note that the compositions of heat transfer liquids can vary among manufacturers, and therefore Sensirion cannot provide specific information regarding their use in vapor phase soldering.

When soldering humidity sensors, it is important to ensure that the maximum temperatures and exposure times are respected to prevent damage to the sensors. If the PCB goes through multiple solder cycles, we recommend assembling in the last solder cycle to reduce the risk of sensor pollution<sup>6</sup>. The use of "no clean" type  $\geq 3$  solder paste<sup>7</sup> is strongly recommended as it eliminates the need for a board wash, which can be harmful to the sensors.

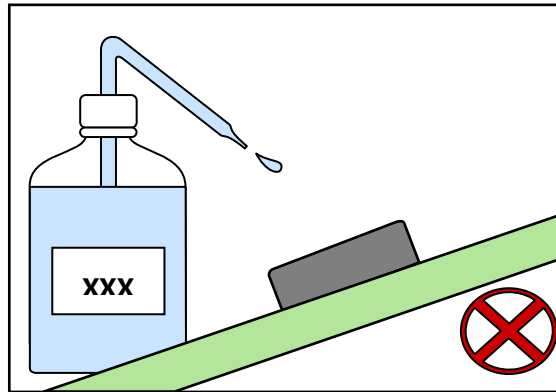

**Instruction 4.** Do not apply board wash.

It is important to use the appropriate amount of solder paste to achieve a stand-off height (clearance between the package body and the substrate) of 50-75  $\mu\text{m}$ . Please consult the corresponding sensor datasheet for more information on the metal land pattern and recommendations on solder paste printing stencils. Standard pick & place equipment and vacuum nozzles for standard QFN packages can be used for assembly of SHTxx sensors.

Manual soldering is not recommended, and rework soldering should be limited to five seconds at up to 350 °C. Additionally please note that after exposure to high temperatures, such as during reflow soldering, humidity sensors may temporarily read a negative humidity offset, typically between -1...-2 %RH. This offset will disappear by itself when the sensor is exposed to ambient conditions, typically within one to three days. If humidity testing is performed immediately after reflow soldering, this offset should be considered when defining the test limits.

It is important to note that the diced edge or side faces of the I/O pads may oxidize over time, so a solder fillet may or may not form. Therefore, there is no guarantee for solder joint fillet heights of any kind.

Sensors in SMT packages are classified as Moisture Sensitivity Level 1 (IPC/JEDEC J-STD-020), meaning that it is recommended to process the sensors within 1 year of the date of delivery to ensure optimal performance. Before beginning the assembly process, it is important to carefully read the User's Guide and Datasheets to ensure proper handling and usage of the sensors.

It is important to note that no mechanical force should be applied to any part of the sensor during assembly or usage to prevent damage.

To protect electronic assemblies, including soldered contacts of sensors, in corrosive environments such as condensed water or corrosive gases, a passivation should be applied. This can be done through conformal coating or an adhesive. However, it is important to use high viscous conformal coatings or potting materials to avoid flowing into the sensor opening and covering the sensing element, rendering the humidity sensor inoperable. Alternatively use the Sensirion solution with protective cover. Additionally, the sensor opening should not be covered with any coating, so that the top surface of the sensor remains free.

<sup>6</sup> Max. 3 solder cycles with sensor.

<sup>7</sup> Solder types are related to the solder particle size in the paste: Type 3 covers the size range of 25 – 45  $\mu\text{m}$  as specified in IPC J-STD-005A

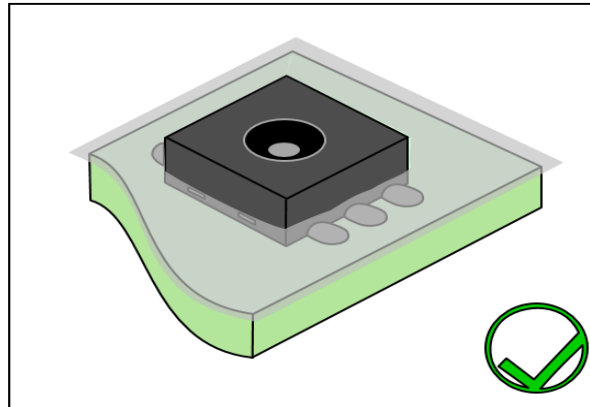

**Instruction 5.** If conformal coating is applied, the top surface of the sensor must remain free of coating.

When applying conformal coatings to electronic assemblies, it's important to keep in mind that solvent vapors are produced during the curing and processing of the coating. Proper ventilation should be established throughout the application, staging, and curing process to prevent pollution of the sensor. This can be achieved by using ovens with fresh air supply, to ensure that the concentration of these gaseous substances remains low.

It is important to follow the manufacturer's guidelines for coating thickness and curing times, and to apply the upper time limit if provided. This is especially important if the PCB design features large components with undercuts, where high layer thicknesses on/under components or drain-off edges can form. Tack-free state of the coating is not an indication of full curing, so be sure to refer to the application notes of the manufacturer for full curing. It is also important to ensure process stability for coating thickness and apply corresponding safety margins for curing times.

**Table 2** lists conformal coatings that have been tested for pollution of the humidity sensor and are known to be suitable if applied and fully cured under good ventilation and according to the respective datasheet. Some coatings are specifically marked as non-compatible. Please note that this recommendation is valid from January 2023, but the suitability of a coating might change without prior notification if the manufacturer changes the formulation of the product.

Manufacturer	Product	Compatibility
Peters	SL 1307 FLZ 23	Compatible
Peters	Elpeguard SL 1301 ECO-BA-FLZ	Not compatible
Peters	Elpeguard SL 1307	Not compatible
Peters	Elpeguard DSL 1706FLZ	Not compatible
Dow Corning	1-2620	Compatible
Humiseal	1R32A-2	Compatible
Humiseal	1B51NSLU	Compatible
Humiseal	1B12LU	Not Compatible
Humiseal	1A27	Not Compatible
Humiseal	1B73EPA	Not Compatible

**Table 2.** Conformal coating compatibility.

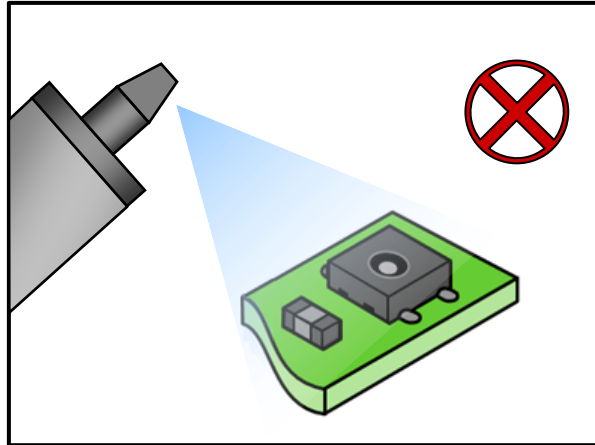

**Instruction 6.** Do not apply spray to unprotected sensor.

When using spray coating techniques, such as applying varnish or conformal coating, it is recommended to use the SHT4x sensor with the protective cover option.

If adhesive tapes need to be used, we only recommend tapes listed in **Table 3**.

Manufacturer	Product	Compatibility
3M	Kapton® Electrical Tape 92	Compatible

**Table 3.** Adhesive Tape compatibility



**Instruction 7.** In conjunction with the sensor, use only recommended Kapton® tape Electrical Tape 92 by 3M™. Do not apply any other adhesive tapes such as Scotch Tape, Sello Tape, Tesa Film etc.

Please use the materials listed in the following tables for adhesives and encapsulants. They have been tested and are recommended for use, as long as they are applied and fully cured in a well-ventilated environment with fresh air supply. Be cautious when using materials and brands that are not listed in the tables, as they may be harmful. Always test them carefully before use. Please note that this recommendation is valid from January 2023, but the compatibility might change without prior notification if the manufacturer changes the formulation of the product.

Manufacturer	Product	Compatibility
EPO-TEK	H70E/S	Compatible
EPO-TEK	T6067	Compatible
EPO-TEK	93-86	Compatible
Lord	MD-130	Compatible
Eccobond	E3503-1	Compatible
Ablebond	84-3	Compatible

**Table 4.** Epoxy Adhesive compatibility.

Manufacturer	Product	Compatibility
Stycast	50300 / 50400 series	Compatible
Hysol	EO1061/EO1062	Compatible

**Table 5.** Epoxy Glob Top compatibility.

Manufacturer	Product	Compatibility
RTV	6424 (Momentive)	Compatible
Dow Corning	732	Compatible

**Table 6.** Silicone Adhesives compatibility.

Manufacturer	Product	Compatibility
Stycast	S 7503	Compatible

**Table 7.** Silicone Glob Top Encapsulants compatibility.

Manufacturer	Product	Compatibility
Loctite	401	Compatible

**Table 8.** Instant Adhesives compatibility.

Manufacturer	Product	Compatibility
Peters	VU 4457-61	Compatible

**Table 9.** PUR (Polyetherane) Casting Compounds compatibility.

Hot melts may absorb moisture, consequently influencing the response time of the sensor found in the device. Therefore, hot melt should be used judiciously.

Firstly, it is recommended to place the sensor in the device only when all the materials used in the assembly process have completely cured or dried up, and in case they have not, to ensure proper ventilation is available in the curing ovens and assembly lines. Secondly, care should be taken to prevent any dust or particles from entering the sensor entrance, as this can impact its performance. It is advisable to wear clean gloves or finger cots while handling the sensor and avoid touching the sensor entrance.

During repair and rework of assemblies containing sensors, it is recommended to cover the sensor with Kapton tape, as per the specific recommendation in **Table 3**. Additionally, it is important to be cautious when using



potent cleaning agents, such as detergents, alcohols, brominated or fluorinated solvents, as cleaning any part of the product can result in a high concentration of cleaning agents on the sensor. Therefore, it is necessary to remove any sensors or devices containing sensors before cleaning the production area and tools. Finally, it is important to ensure good ventilation and that any solvents have evaporated before resuming production to prevent any damage to the sensors.

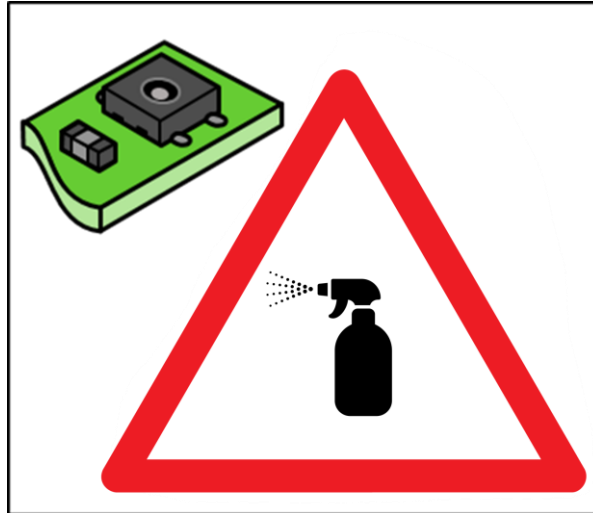

**Instruction 8.** Prevent sensor from exposure to cleaning agents.

### 3 Operation in the Field

When operating a capacitive humidity sensor in the field, there are generally no impairments to its performance if the design is good, see Design-In Guide [2]. However, wrongful exposure to chemicals and other contaminants can lead to degradation of the sensor's accuracy over time. Please refer to section 1.3 to see a list of known chemicals that can have an impact on the sensors performance if not handled with care. This is because contaminants can induce a change in the dielectric constant of the sensing material like water molecules. As the sensor cannot distinguish if the induced change comes from contaminants or water molecules, they can falsify the measurement. While water desorbs once the humidity of the environment decreases, some contaminants are bound too strongly and will not leave the system. This leads to an irreversible drift in the sensors reading not to be confused with the reversible creep of sensors used at extreme conditions (high temperature and relative humidity above 90%) [3].

To combat this induced drift, the newest sensors are equipped with a heater that help to free the sensor from different types of contaminants. Please follow the protocol in the document Creep\_Mitigation\_SHT4x [3] to ensure continuous drift mitigation. It is important to note that some contaminants may have a more severe impact on sensor accuracy than others, so it is crucial to consider the environment in which the sensor will be operating when selecting the appropriate design.

### 4 Extreme Conditions and Reconditioning

Certain applications require the exposure of humidity and temperature sensors to extreme conditions, which SHT sensors withstand in most cases. However, certain prophylactic measures must be adopted.

For exposure to extreme humidity and temperature, please refer to the datasheet of the respective product. Make sure that the exposure time of the sensor to the maximum operating conditions is limited as mentioned in the datasheet. Prolonged and high concentration exposure to volatile organic compounds is not only critical during assembly but also in the field. Such applications need to be tested and validated thoroughly. As described above, exposure to acids or bases may also be critical. For it to be critical, their concentration must

be such that the polymers are affected. As a rule of thumb, bases with a pH below 9 are not critical. Etching substances such as H<sub>2</sub>O<sub>2</sub>, NH<sub>3</sub>, etc. in high concentrations are critical to the sensor.

Corrosive substances in low concentrations are not detrimental to the sensor itself. However, they may corrode the soldered contacts. Hence, the contacts must be well-protected (passivated) in potentially corrosive environments – see also Section 2.

The application of Sensirion humidity and temperature sensors to severe conditions must be cautiously tested and validated. Sensirion qualifies its humidity and temperature sensors to function appropriately within ambient clean air – the qualification for use in extreme environments is the responsibility of the user.

As stated above extreme conditions or exposure to solvent vapors may offset the sensor. The following reconditioning procedure may bring the sensor back to calibration state:

- Baking: 100 – 105 °C at <5 %RH for 10 h
- Re-Hydration: 20 – 30 °C at ~75 %RH for 12 h

The 75 %RH can conveniently be generated with a saturated NaCl solution. For further information please refer to the cited article on Humidity Fixed Points of Binary Saturated Aqueous Solutions from the NIST Journal of Research [4].

## 5 Removable Protective Cover

There are some visual anomalies which can occur when handling the removable protective cover. When removing the protective cover some adhesive residues might be left behind on the top surface of the sensor. It shall be noted that this is a purely optical phenomenon which does not affect the sensor functionality.

It also might happen that the anti-adhesion layer, highlighted in **Figure 2** contracts slightly during processes where high temperatures are reached, such as reflow soldering. This change in shape occurs only to the anti-adhesion layer while the protective cover retains its full shape and functionality.

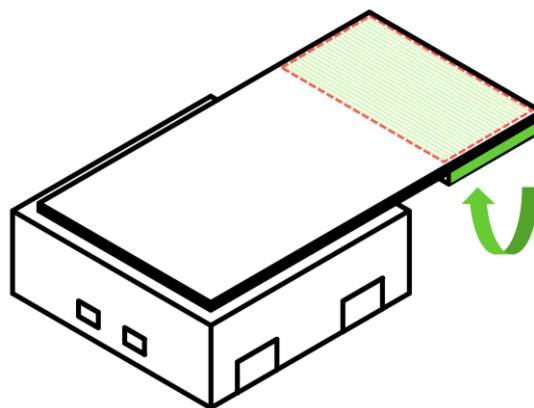

**Figure 2:** Visualization of the anti-adhesion layer of the protective cover

## 6 Bibliography

- [1 Sensirion, "Sensors Specification Statement and Testing Guide," 19 April 2021. [Online]. Available:  
] <https://sensirion.com/products/downloads/>.
- [2 Sensirion, "SHTxx Design Guide," [Online]. Available: [www.sensirion.com](http://www.sensirion.com).  
]
- [3 Sensirion, "Creep Mitigation SHT4x," 04 2022. [Online]. Available:  
] [https://sensirion.com/media/documents/A88858C9/629626D4/Application\\_Note\\_Creep\\_Mitigation\\_SHT4x.pdf](https://sensirion.com/media/documents/A88858C9/629626D4/Application_Note_Creep_Mitigation_SHT4x.pdf).
- [4 L. Greenspan, "Humidity Fixed Points of Binary Saturated Aqueous Solutions," *J Res Natl Bur Stand A Phys Chem*, vol. 81A(1), no. doi: 10.6028/jres.081A.011. Epub 1977 Feb 1. PMCID: PMC5295834., pp. 89-96, 1977.
- [5 IEEE, "IEEE Reference Guide," 2018. [Online]. Available: <https://ieeauthorcenter.ieee.org/wp-content/uploads/IEEE-Reference-Guide.pdf>. [Accessed 20 1 2023].

## 7 Disclaimer

The beforementioned restrictions, recommendations, materials, etc. do not comprise all possible cases and items.

The material recommendations provided are in relation to the pollution of SHTxx sensors and assume ideal processing for averting VOC in the process – the materials were not examined with respect to other characteristics such as dependability, efficacy, usefulness, or mechanical properties. The material recommendations have been compiled with our most advanced knowledge at the time of writing. Manufacturers may alter the compounds without warning, which can lead to decreased sensor performance due to outgassing.

This document is not to be thought of as comprehensive and is subject to change without prior notification.

## 8 Revision History

Date	Revision	Pages	Changes
June 2007	0.1		Initial revision (Preliminary)
January 2009	1.0		Complete rework.
March 2010	1.1		New format, implementation of pictograms.
June 2012	2.0		Moisture Sensitivity Level adapted.
November 2013	3		Document partially restructured and clarifications added.
May 2014	4		ESD bag recommendation changed, reconditioning procedure added
March 2018	5		ESD bag recommendation changed, Pictograms updated, conformal coating added
May 2020	6		Conformal coating recommendation changed; coating information added
June 2021	7		Soldering information added; new suitable conformal coatings added
February 2023	8	All 6 7	Reformatting and reformulation Updated compatible & Incompatible conformal coatings. Updated recommendation from SHT3x to SHT4x

June 2023	8.1	4	Added Disclaimer for Vapor Phase Soldering in section 2
October 2023	8.2	Multiple 9 9 10	Corrected typos Image format changed Changed "absorbs" to "desorbs" Added section about protective cover visual anomalies

## Important Notices

### Warning, Personal Injury

Do not use this product as safety or emergency stop devices or in any other application where failure of the product could result in personal injury. Do not use this product for applications other than its intended and authorized use. Before installing, handling, using or servicing this product, please consult the data sheet and application notes. Failure to comply with these instructions could result in death or serious injury.

If the Buyer shall purchase or use SENSIRION products for any unintended or unauthorized application, Buyer shall defend, indemnify and hold harmless SENSIRION and its officers, employees, subsidiaries, affiliates and distributors against all claims, costs, damages and expenses, and reasonable attorney fees arising out of, directly or indirectly, any claim of personal injury or death associated with such unintended or unauthorized use, even if SENSIRION shall be allegedly negligent with respect to the design or the manufacture of the product.

### ESD Precautions

The inherent design of this component causes it to be sensitive to electrostatic discharge (ESD). To prevent ESD-induced damage and/or degradation, take customary and statutory ESD precautions when handling this product. See application note "ESD, Latchup and EMC" for more information.

### Warranty

SENSIRION warrants solely to the original purchaser of this product for a period of 12 months (one year) from the date of delivery that this product shall be of the quality, material and workmanship defined in SENSIRION's published specifications of the product. Within such period, if proven to be defective, SENSIRION shall repair and/or replace this product, in SENSIRION's discretion, free of charge to the Buyer, provided that:

- notice in writing describing the defects shall be given to SENSIRION within fourteen (14) days after their appearance;
- such defects shall be found, to SENSIRION's reasonable satisfaction, to have arisen from SENSIRION's faulty design, material, or workmanship;
- the defective product shall be returned to SENSIRION's factory at the Buyer's expense; and
- the warranty period for any repaired or replaced product shall be limited to the unexpired portion of the original period.

This warranty does not apply to any equipment which has not been installed and used within the specifications recommended by SENSIRION for the intended and proper use of the equipment. EXCEPT FOR THE WARRANTIES EXPRESSLY SET FORTH HEREIN, SENSIRION MAKES NO WARRANTIES, EITHER EXPRESS OR IMPLIED, WITH RESPECT TO THE PRODUCT. ANY AND ALL WARRANTIES, INCLUDING WITHOUT LIMITATION, WARRANTIES OF MERCHANTABILITY OR FITNESS FOR A PARTICULAR PURPOSE, ARE EXPRESSLY EXCLUDED AND DECLINED.

SENSIRION is only liable for defects of this product arising under the conditions of operation provided for in the data sheet and proper use of the goods. SENSIRION explicitly disclaims all warranties, express or implied, for any period during which the goods are operated or stored not in accordance with the technical specifications.

SENSIRION does not assume any liability arising out of any application or use of any product or circuit and specifically disclaims any and all liability, including without limitation consequential or incidental damages. All operating parameters, including without limitation recommended parameters, must be validated for each customer's applications by customer's technical experts. Recommended parameters can and do vary in different applications.

SENSIRION reserves the right, without further notice, (i) to change the product specifications and/or the information in this document and (ii) to improve reliability, functions and design of this product.

### Headquarters and Subsidiaries

#### Sensirion AG

Laubisruetistr. 50  
CH-8712 Staefa ZH  
Switzerland

phone: +41 44 306 40 00  
fax: +41 44 306 40 30  
[info@sensirion.com](mailto:info@sensirion.com)  
[www.sensirion.com](http://www.sensirion.com)

#### Sensirion Taiwan Co. Ltd

phone: +886 2 2218-6779  
[info@sensirion.com](mailto:info@sensirion.com)  
[www.sensirion.com](http://www.sensirion.com)

#### Sensirion Inc., USA

phone: +1 312 690 5858  
[info-us@sensirion.com](mailto:info-us@sensirion.com)  
[www.sensirion.com](http://www.sensirion.com)

#### Sensirion Japan Co. Ltd.

phone: +81 45 270 4506  
[info-jp@sensirion.com](mailto:info-jp@sensirion.com)  
[www.sensirion.com/jp](http://www.sensirion.com/jp)

#### Sensirion Korea Co. Ltd.

phone: +82 31 337 7700~3  
[info-kr@sensirion.com](mailto:info-kr@sensirion.com)  
[www.sensirion.com/kr](http://www.sensirion.com/kr)

#### Sensirion China Co. Ltd.

phone: +86 755 8252 1501  
[info-cn@sensirion.com](mailto:info-cn@sensirion.com)  
[www.sensirion.com/cn](http://www.sensirion.com/cn)

To find your local representative, please visit  
[www.sensirion.com/distributors](http://www.sensirion.com/distributors)