

ASL1600

Media Isolated Liquid Mass Flow Meter

- Totally non-invasive
- Maximum flows up to 4 ml/min
- Resolutions down to 100 nl/min
- Response time 30 ms
- RS-232 digital interface

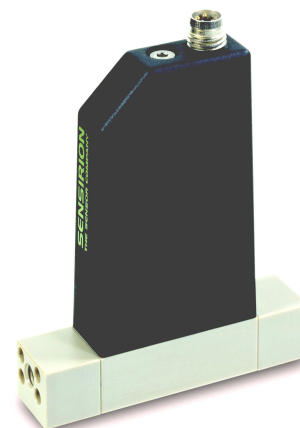

May 2009 V1.1

ASL1600 Product Summary

The ASL1600 Liquid Mass Flow Meter enables extremely fast and accurate measurements of ultra low liquid mass flows. This particularly small and light device operates with total media isolation, hardly any dead volume and no moving parts. The unique performance of this Swiss made device is based on Sensirion's unsurpassed CMOSens[®] sensor technology which combines a high precision thermal sensor element with the amplification and A/D converter circuit and digital signal processing on one single CMOS chip. This results in superior resolution, fast response time and large dynamic range at low power consumption.

All measurement data is fully calibrated and temperature compensated by means of an internal microcontroller.

Excellent chemical resistance and bio-compatibility are ensured. The medium only gets in contact with the straight sensor capillary made of Duran[®]- (borosilicate glass 3.3), with the PEEK[™]-fittings and with Teflon[®] used as sealing material. Typical applications for this sensor include precise liquid mass flow and volume measurement for analytical instruments, medical devices, process control.

The ASL1600 requires a supply voltage of 7...18 V_{DC} and provides an RS-232 compliant digital interface.

CMOSens[®] Technology

CMOSens[®] is the base technology for all Sensirion microsensor products. The unification of CMOS and sensor technology serves as a platform for highly integrated system solutions with excellent sensor precision and reliability. Inside the ASL1600 the on-chip sensor element forms an integrated whole with a high-end amplification A/D converter circuit. Due to this compact single-chip design, CMOSens[®] based sensors are very resistant to electromagnetic disturbances (EMC), another important technical advantage of this state of the art sensor technology. As a result, CMOSens[®] based sensor modules offer excellent sensor precision, fast response time and a very large dynamic measurement range. In addition, the digital intelligence of the CMOSens[®] sensor technology enables digital interfaces that permit an easy link with the system of the customer,

a real advantage and benefit that results in ready-to-use problem solutions.

The core element of CMOSens[®] liquid mass flow sensors is formed by mounting the highly sensitive microchip on the outside of a straight glass capillary (US Patent 6,813,944 B2). The liquid mass flow in the capillary is measured through the tubing material guaranteeing a total media isolation.

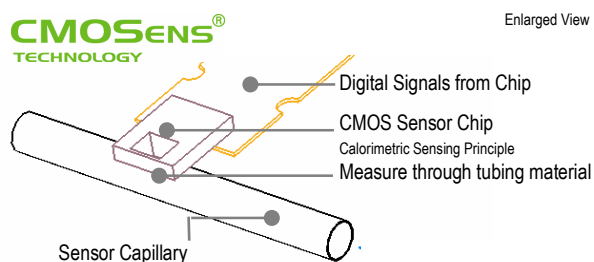

1 Liquid Mass Flow Sensor Performance

Table 1: Overview ASL1600 Liquid Flow Sensor Performance (all data for 23°C, 1 bar_{abs} unless otherwise noted).

Parameter	Condition	ASL1600-10	ASL1600-20	Units
Liquid Flow Sensor				
Maximum Flow (bi-directional)		1000	4000	µl/min
Calibrated Minimum Flow		40	200	µl/min
Accuracy ^d	Flow ≥ Calibrated Minimum Flow	3.0 ^{a,d}	3.0 ^{a,d}	% of measured value
	Flow ≤ Calibrated Minimum Flow	0.15 ^{a,d}	0.15 ^{a,d}	% of full scale
Best Resolution ^b	at calibrated min. flow	0.1	0.3 ^d	µl/min
	at maximum flow	1.5	5.0	µl/min
Pressure Drop	at maximum flow	<100	<100	Pa ^c
Repeatability	reference conditions ^d	<0.8	<0.8	% of measured value
Overpressure related Offset		0	0	% FS / bar
Overpressure Resistance ^e		5	3	bar ^d
Flow Detection Response Time		30	30	ms
Digital Sampling Time (Data Readout)	depends on resolution setting (see Table 2)	5	5	ms
Operating Temperature	avoid freezing	+0...+60	+0...+60	°C
Temperature Coefficient	25%...75% of max. flow	<0.2	<0.2	% MV / K
	<25% or >75% of max flow	<0.4	<0.4	% MV / K
Mounting Orientation Sensitivity ^f		<1.5	<3	% of full scale
Temperature Sensor				
Measures temperature inside the sensor chip, but not of the surrounding air ^g				
Dynamic Range		+10...50	+10...50	°C
Resolution		0.1	0.1	°C
Accuracy		3	3	°C

Table 2: Resolution at Different Flow Levels and Integration Times^c

Sensor Resolution	Readout Frequency 200 Hz	Readout Frequency 50 Hz	Readout Frequency 12.5 Hz	Readout Frequency 1.56 Hz
Best Resolution to be multiplied by ...	64	16	4	1
Mass Flow Integration Time	5 ms	20 ms	80 ms	640 ms

^a Better available on request. For best results allow the sensor to warm up.

^b See Table 2

^c 1 bar = 100 000 Pa = 0.9869 atm = 401.9 inch H₂O = 14.5 psi

^d Reference conditions: 1 bar_{abs}, T= 20°C, medium H₂O, vertical mounting (electrical connector up)

^e Overpressure in operation; High overpressure resistance for OEM-solutions on request

^f For low flow measurements with high accuracy vertical mounting position (connector up) is recommended

^g The chip warms up by about 4K (depending on supply voltage and ventilation)

1.1 Sensor Principle and Liquid Media

The ASL1600 device detects liquid mass flow by measuring heat transfer through the tubing material of a glass capillary. On a microchip outside the capillary, a heating resistor on a thermally optimized membrane is kept above ambient temperature. In the presence of liquid flow inside the capillary, the temperature distribution up- and downstream is disturbed. This asymmetry is then measured. Due to the minimal thermal mass of the system, symmetrical arrangement, and accurate temperature measurement, the revolutionary specifications of the ASL1600 devices are achieved while providing total media isolation.

The above-mentioned thermal principle depends on the physical properties of the liquid used. The ASL1600 is calibrated for water only but the use of other liquids is also possible. The sensor guarantees an outstanding repeatability for a wide range of different media though offset, sensitivity and measurement range may change. It is recommended to characterize the sensor output separately when starting to perform such measurements. Units calibrated directly for other liquid types are available on request when high volumes are needed.

1.2 ASL1600 Transfer Characteristics

Figure 1 shows the applied liquid flow vs. the digital output of the ASL1600-20. The characteristics is linear for the medium water. Beyond the limits of the output (ca. calibrated maximum flow + 10%), the signal remains constant.

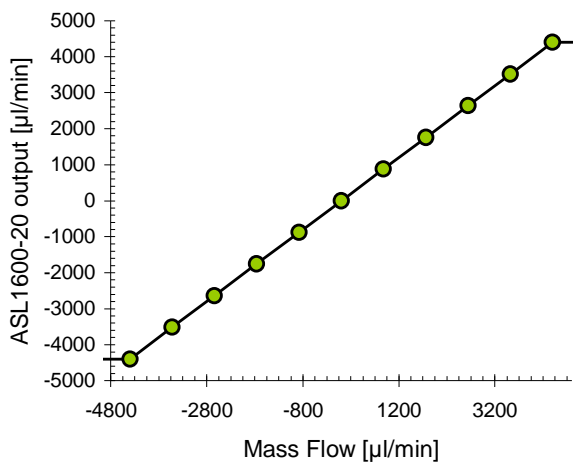

Figure 1: ASL1600 transfer characteristics for H2O calibrated output

1.3 Raw Data Mode

For applications where high repeatability is most important and different types of media are used, the sensor can be switched^a to raw data mode. By doing this non-linear effects can be monitored without influence of the internal calibration data.

Figure 2 shows the applied liquid flow vs. the digital output of the ASL1600 in raw data mode.

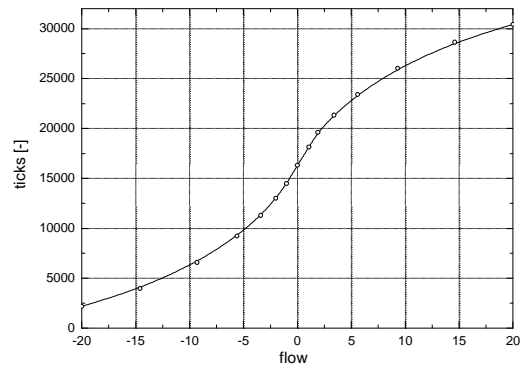

Figure 2: Qualitative transfer characteristics of ASL1600 in raw data mode.

1.4 Offset

After exposing the sensor to extreme conditions or when using other media than water a slight offset on the sensor output may occur. In this case an offset correction^a may be useful if best accuracy is needed.

^a Ask for support for this operation

2 Digital Interface and Power Supply

For communication and power supply the ASL1600 is equipped with a 4-pin M8 connector IEC 60947-5-2 (e.g. Hirschmann E Series M8). (Pigtail cables for this connector are available at Sensirion. Refer to article number 1-100136-01)

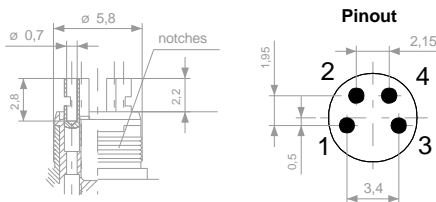

Figure 3: Connector for RS232 and power supply with pinout view from outside

Pin	Description
1	VDD
2	TxD (Sensor Transmitting Data)
3	RxD (Sensor Receiving Data)
4	GND (Ground)

GND and VDD (Power Supply)

The ASL1600 requires a voltage supply of between 7V and 18 V. Since this voltage is internally regulated, there are no stringent requirements as far as ripple and stability are concerned.

2.1 Digital Interface Dataformat

The ASL1600 has a bi-directional RS-232 interface to set configuration and to get flow or temperature values. The received value is a 16 bit integer in the two's complement representation.

received value (hex)	received value (dec)	flow [μl/min]	temperature [°C]
0x7EFF	32511	+1548.140	+320.00*
⋮	⋮	⋮	⋮
0x0001	1	+0.0476	0.01
0x0000	0	0.0000	0.00
0xFFFF	-1	-0.0476	-0.01
⋮	⋮	⋮	⋮
0x8101	-32511	-1548.140	-320.00*

*not possible value, just to show the principle

Table 3: Interpretation of integer values

The calibrated data is multiplied by a constant factor and then rounded to the next smaller integer in order to transfer also fractions of a unit through the integer protocol. Example: with factor=21 a received value of

+1234 (dec) corresponds either to 58.76 μl/min in flow mode or 12.34 °C in temperature mode. Always use the 'info' command to determine individual values of your sensor. (see Table 5)

RS-232 Interface

All configurations (see also Section 3) for the ASL1600 can be set using its RS-232 interface. The following pins are required to communicate with the ASL1600 via RS-232:

- RxD (Receiving Data Line)
- TxD (Transmitting Data Line)
- GND (Ground)

The RS-232 protocol of the ASL1600 is configured as follows:

Baud Rate	19200
Data Bits	8
Stop Bits	1
Parity	none
Protocol	none
Echo	the sensor generates an echo

With these settings, the ASL1600 device can be connected to any PC or device with an RS-232. The commands have to be sent in ASCII format, the measurement values are provided as a 16 bit integer in binary format with 2 bytes synchronization preceding.

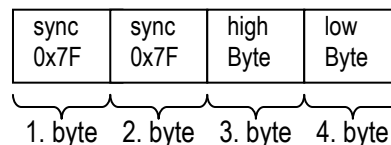

Figure 4: Byte sequence of one value

Because of the maximum range of 0x7EFF, the high byte will never contain 0x7F. So, the worst case is, if the lower byte contains 0x7F. In this special case, 0x7F appears three times in a row.

Example (val=7C 7F):

received string: 7F 7F 7C 7F 7F 7F 7C 7F
 right sync: 7F 7F 7C 7F 7F 7F 7C 7F
 wrong sync: 7F 7F 7F 7C

The best approach to find the sync in pseudo code: if (buffer[i]=7F and buffer[i+1]=7F and buffer[i+2] <> 7F) then buffer[i] and buffer[i+1] are sync bytes.

3 Configuration and Commands

The ASL1600 device accepts a set of commands through its RS-232 interface (see 0 for valid commands; for correct settings of the RS-232 refer to Section 2.1). This allows the user to configure the ASL1600 device. Since the configuration is stored in the internal EEPROM, it is maintained after power interruptions.

With the exception of the stop **s** command, all commands have to be sent in the ASCII-format and terminated by the return key (\downarrow , ASCII #10 or #13; never #10 and #13). After completion of a command, the ASL1600 returns **ok** and is ready to accept a new instruction^a. Before entering a command, it might be necessary to clear the buffer by means of using \downarrow .

There is a trade-off between resolution and measurement time. Possible settings are listed in Table 4. For example, choosing 12 bit resolution

results in a measurement interval of 80 ms. With the max resolution of 15 bit, a new measurement is provided every 640 ms.

Table 4: Resolution settings using the **res=value** command and corresponding response times

res=	Resolution [bit]	Internal signal integration time [ms]	Data rate [Hz]
0	8	5	200
1	9	10	100
2	10	20	50
3	11	40	25
4	12	80	12.5
5	13	160	6.25
6	14	320	3.125
7	15	640	1.56

Table 5: RS-232 interface commands

Command	Output	Description
help \downarrow	commands	Lists all available commands
ver \downarrow	version	Provides type of sensor, firmware version and article number
info \downarrow	calibration	Unit / Factor Flow / Overflow / Sensitivity / Factor Temperature
data \downarrow	serial ID	Sensor serial number
go \downarrow		Starts series of measurements
s	stop	Stops series of measurements
get \downarrow		Start single measurement (lifetime limitation: 1 Mio cycles)
mod=F T \downarrow ^a	mode	Selects flow- (F) or temperature mode (T), (mod? = Status)
res=0..7 \downarrow ^a	resolution	Sets resolution: 0 -> 8 bits; 7 -> 15 bits, see Table 4, (res? = Status)
int=x \downarrow ^a		x=number of 5 ms intervals between automatic internal temperature measurements for an update of the temperature compensation (duration: 45 ms). 0=never, {1..2*10 ⁹ }. (INT? = Status). Flow is NOT measured during this internal temperature update!
updatetemp \downarrow		Manual command for an internal temperature measurement for internal update of the temperature compensation. Used with int=0
rdatax \downarrow		Reads 4 user defined bytes at the address x={0,...,9}
wdatax=yyyy \downarrow		Writes a maximum of 4 user defined bytes at the address x={0,...,9}
test \downarrow		Sensor selftest
reset \downarrow		Resets ASL1600 device
pw=expand		Switch security mode off. Allows selecting raw data mode.
raw= 1 0		Selects data mode: 1=raw data, 0 = linearized, temp. compensated data

Notes:

- Due to the limited write cycles allowed (lifetime limitation: 1 Mio cycles) for the EEPROM, excessive configuration modifications should be avoided. Even the get-command underlies this limitation.
- The commands are not case sensitive.

^a The commands mod?, res? and int? do not return ok

- In order to send a new command to the ASL1600, make sure the ASL1600 is not in measurement mode. Issue therefore a stop command **s** first. After this, any instruction can be given to the ASL1600 and a new series of measurements can be started by **go**.

RS232 Communication Error Codes

ERROR 01	Invalid command
ERROR 02	Wrong syntax
ERROR 03	Value out of range
ERROR 04	Not allowed mode
ERROR 50	Invalid EEPROM
ERROR 99	Internal error

4 Electrical and Mechanical Specifications ASL1600

4.1 Absolute Maximum Ratings

Ambient storage temperature	-10°C to 60°C
Ambient operating temperature	0°C to 60°C
Overpressure resistance	5.0 bar

4.2 Electrical Specifications

Table 6: ASL1600 DC Characteristics.

Parameter	Conditions	Min.	Typ.	Max.	Units
Power Supply DC	DC, abs. maximum rating	7	9	18	V
Operating Current	VDD = 9 V, no load		20		mA
	VDD = 9 V, 3kΩ at RS232 output		27		mA
Power Dissipation	VDD = 9 V, no load		180		mW

Table 7: ASL1600 RS-232 Characteristics.

Parameter	Conditions	Min.	Typ.	Max.	Units
RS232 Output					
Output Voltage Swing	Transmitter output loaded with 3kΩ	±5	±9		V
Power-Off Output Resistance		300			Ω
Output Short Circuit Current			±18		mA
RS-232 Input					
Voltage Range	abs. maximum rating	-15		15	V
Voltage Threshold					
Low		0.8	1.2		V
High			1.7	2.4	V
Hysteresis		0.2	0.5	1.0	V
Resistance		3	5	7	kΩ

4.3 Mechanical Specifications

Wetted Materials

The medium only gets in contact with the straight sensor capillary made of Duran®- (borosilicate glass 3.3), with the PEEK™-fittings and with Teflon® used as sealing material.

Table 8: Mechanical Specifications

Parameter	Conditions	ASL1600-10	ASL1600-20	Units
Fluid Connectors		UNF 10-32 2B		
Connected Fluid Capillary, Inner Diameter	See Remark Below	≥0.5	≥0.8	mm
Connected Fluid Capillary, Outer Diameter		1.6	1.6	mm
		1/16	1/16	inch
Internal Sensor Capillary, Inner Diameter		1.0	2.0	mm
Total Mass		36		g

Remark

The inner diameter of the **connected fluid capillary** at the inlet of the ASL1600 must not be smaller than the specified value above. A smaller inner diameter may cause turbulences which influence the accuracy of the measurement. Make sure the capillary has been cut in the right way without squeezing.



5 Physical Dimensions

The ASL1600 housing is made of chemically inert PBT. For physical dimensions see Figure 5:

Figure 5:

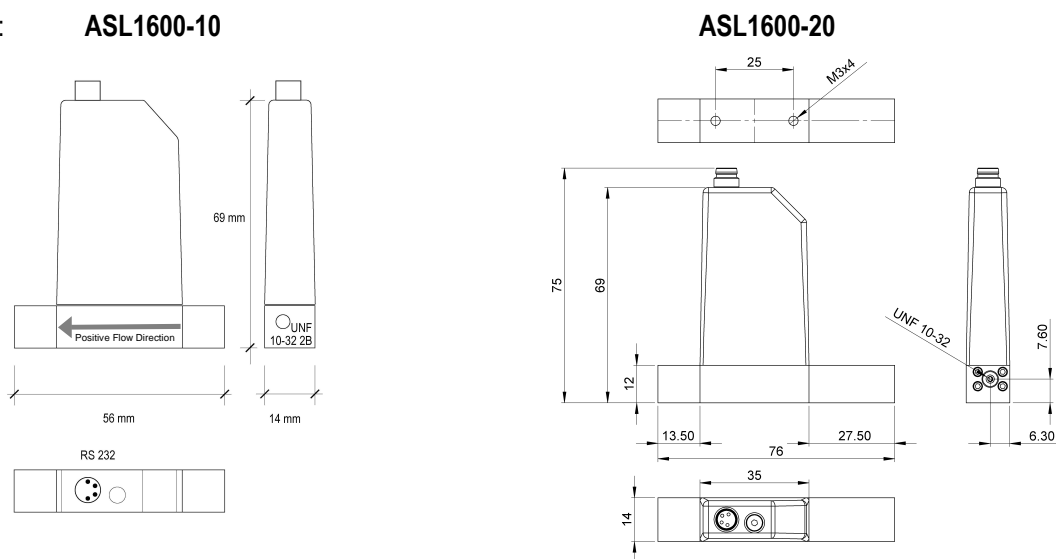

6 Ordering Information

For laboratory use and technology evaluation, the LabKit ASL1600 can be ordered.

This laboratory-package contains

- Liquid Flow Sensor ASL1600-10/20
- UNF10-32 Fitting Material
- PC Software (Viewer & Data Export Tool)
- Data Cable RS232
- A/C Adaptor (110...230 V, 50..60Hz)

For OEM applications the sensor can be purchased in larger quantities without any additional parts.

Product	Article Number
LabKit ASL1600-20	1-100421-01
ASL1600-20	1-100423-01
LabKit ASL1600-10	1-100422-01
ASL1600-10	1-100420-01

7 Important Notices

7.1 Warning, personal injury

Do not use this product as safety or emergency stop devices or in any other application where failure of the product could result in personal injury. Do not use this product for applications other than its intended and authorized use. Before installing, handling, using or servicing this product, please consult the data sheet and application notes. Failure to comply with these instructions could result in death or serious injury.

If the Buyer shall purchase or use SENSIRION products for any unintended or unauthorized application, Buyer shall defend, indemnify and hold harmless SENSIRION and its officers, employees, subsidiaries, affiliates and distributors against all claims, costs, damages and expenses, and reasonable attorney fees arising out of, directly or indirectly, any claim of personal injury or death associated with such unintended or unauthorized use, even if SENSIRION shall be allegedly negligent with respect to the design or the manufacture of the product.

7.2 ESD Precautions

The inherent design of this component causes it to be sensitive to electrostatic discharge (ESD). To prevent ESD-induced damage and/or degradation, take customary and statutory ESD precautions when handling this product.

See application note "ESD, Latchup and EMC" for more information.

7.3 Warranty

SENSIRION warrants solely to the original purchaser of this product for a period of 12 months (one year) from the date of delivery that this product shall be of the quality, material and workmanship defined in SENSIRION's published specifications of the product. Within such period, if proven to be defective, SENSIRION shall repair and/or replace this product, in SENSIRION's discretion, free of charge to the Buyer, provided that:

- notice in writing describing the defects shall be given to SENSIRION within fourteen (14) days after their appearance;
- such defects shall be found, to SENSIRION's reasonable satisfaction, to have arisen from SENSIRION's faulty design, material, or workmanship;
- the defective product shall be returned to SENSIRION's factory at the Buyer's expense; and
- the warranty period for any repaired or replaced product shall be limited to the unexpired portion of the original period.

This warranty does not apply to any equipment which has not been installed and used within the specifications recommended by SENSIRION for the intended and proper use of the equipment. EXCEPT FOR THE WARRANTIES EXPRESSLY SET FORTH HEREIN, SENSIRION MAKES NO WARRANTIES, EITHER EXPRESS OR IMPLIED, WITH RESPECT TO THE PRODUCT. ANY AND ALL WARRANTIES, INCLUDING WITHOUT LIMITATION, WARRANTIES OF MERCHANTABILITY OR FITNESS FOR A PARTICULAR PURPOSE, ARE EXPRESSLY EXCLUDED AND DECLINED.

SENSIRION is only liable for defects of this product arising under the conditions of operation provided for in the data sheet and proper use of the goods. SENSIRION explicitly disclaims all warranties, express or implied, for any period during which the goods are operated or stored not in accordance with the technical specifications.

SENSIRION does not assume any liability arising out of any application or use of any product or circuit and specifically disclaims any and all liability, including without limitation consequential or incidental damages. All operating parameters, including without limitation recommended parameters, must be validated for each customer's applications by

customer's technical experts. Recommended parameters can and do vary in different applications.

SENSIRION reserves the right, without further notice, (i) to change the product specifications and/or the information in this document and (ii) to improve reliability, functions and design of this product.

Copyright© 2001-2009, SENSIRION.
 CMOSens® is a trademark of Sensirion
 All rights reserved.

PEEK™ is a trademark of Victrex PLC
 Teflon® is a registered trademark of DuPont Corporation
 Duran® is a trademark of the SCHOTT-Group

7.4 FCC and CE Statement

This product has been tested and found to comply with the limits for a Class B digital device, pursuant to part 15 of the FCC Rules (FCC CFR 47). These limits are designed to provide reasonable protection against harmful interference in a residential installation. This equipment generates, uses and can radiate radio frequency energy and, if not installed and used in accordance with the instructions, may cause harmful interference to radio communications. However, there is no guarantee that interference will not occur in a particular installation. If this equipment does cause harmful interference to radio or television reception, which can be determined by turning the equipment off and on, the user is encouraged to try to correct the interference by one of more of the following measures:

- Reorient or relocate the receiving antenna.
- Increase the separation between the equipment and the receiver
- Connect the equipment into an outlet on a circuit different from that to which the receiver is connected.
- Consult a dealer or an experienced radio/TV technician for help.



The devices fully comply with norm EN 50081-2 (Emission Test Series) as well as EN 50082-2 (Immunity Test Series).

7.5 RoHS and WEEE Statement

The ASL1600 product family complies with requirements of the following directives:

- EU Directive 2002/96/EC on waste electrical and electronic equipment (WEEE), OJ13.02.2003; esp. its Article 6 (1) with Annex II.
- EU Directive 2002/95/EC on the restriction of the use of certain hazardous substances in electrical and electronic equipment (RoHS), OJ 13.02.2003; esp. its Article 4.



Headquarter and Sales Office

SENSIRION AG
Laubisruetistr. 50
CH-8712 Staefa ZH
Switzerland

Phone: +41 44 306 40 00
Fax: +41 44 306 40 30
info@sensirion.com
<http://www.sensirion.com>

SENSIRION Korea Co. Ltd.
#1414, Anyang Construction Tower B/D,
1112-1, Bisan-dong, Anyang-city,
Gyeonggi-Province, South Korea

Phone: +82-31-440-9925~27
Fax: +82-31-440-9927
info@sensirion.co.kr
<http://www.sensirion.co.kr>

SENSIRION Inc.
Westlake Pl. Ctr. I, suite 204
2801 Townsgate Road
Westlake Village, CA 91361
USA

Phone: +1 805 409 4900
Fax: +1 805 435 0467
michael.karst@sensirion.com
<http://www.sensirion.com>

SENSIRION China Co. Ltd.
Room 2411, Main Tower
Jin Zhong Huan Business Building,
Futian District, Shenzhen, PR China
Postal Code 518048

Phone: +86 755 8252 1501
Fax: +86 755 8252 1580
info@sensirion.com.cn
<http://www.sensirion.com.cn>

SENSIRION Japan
Sensirion Japan Co. Ltd.
Shinagawa Station Bldg. 7F
4-23-5 Takanawa
Minato-ku, Tokyo, Japan

Phone: +81 3-3444-4940
Fax: +81 3-3444-4939
info@sensirion.co.jp
<http://www.sensirion.co.jp>

Find your local representative at: <http://www.sensirion.com/reps>